

DISEGNA IL TUO TOAST CON QUESTI SIMPATICI STENCIL

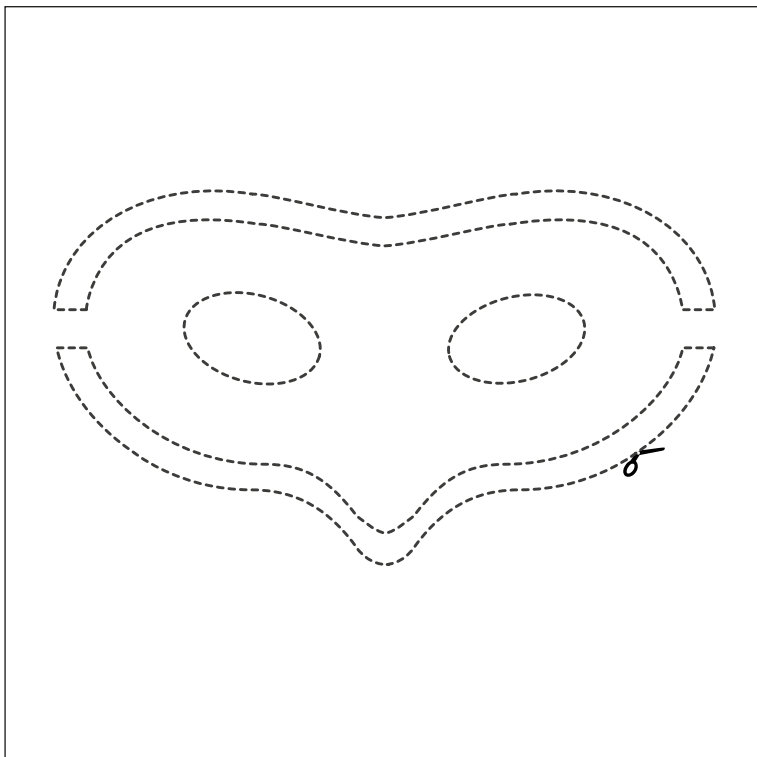

Istruzioni

- 1** Ritaglia il disegno che preferisci da un foglio di alluminio. Puoi usare sia il ritaglio che la cornice.

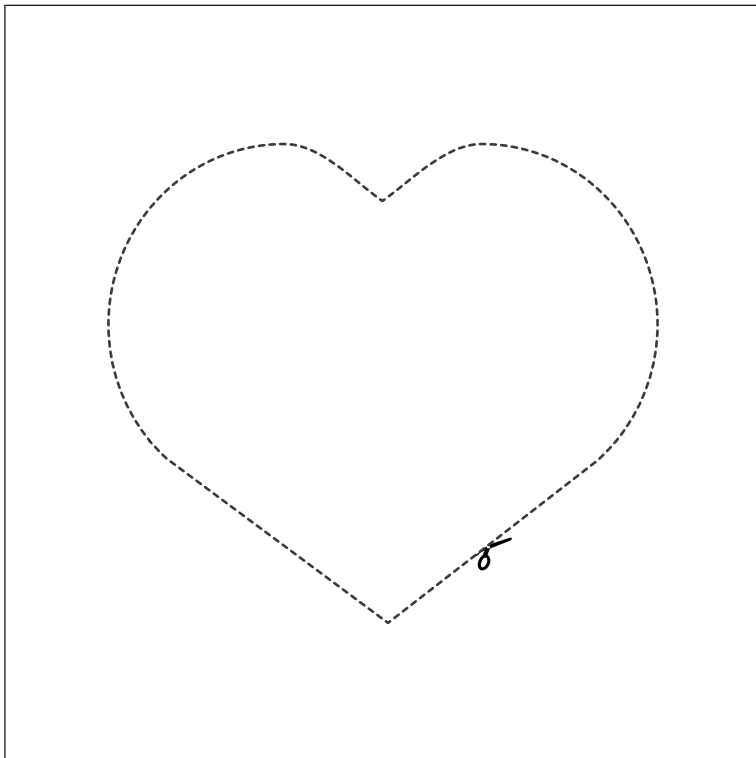
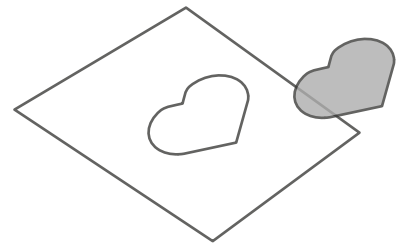

- 2** Copri il pane prima di tostarlo. Fissa il foglio di alluminio con degli stuzzicadenti.

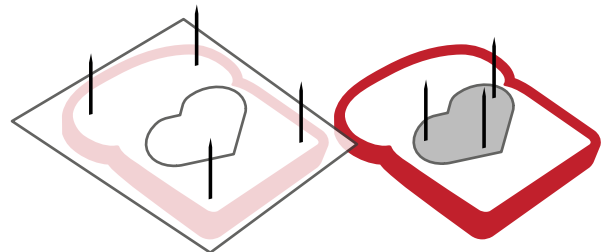

- 3** La parte scoperta rimarrà più scura lasciando visibile il disegno.

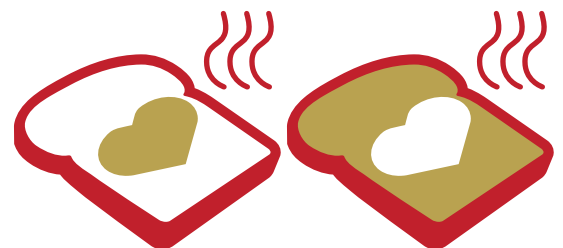



PANINI TOAST -issimi!

**DISEGNA IL TUO TOAST CON
QUESTI SIMPATICI STENCIL**

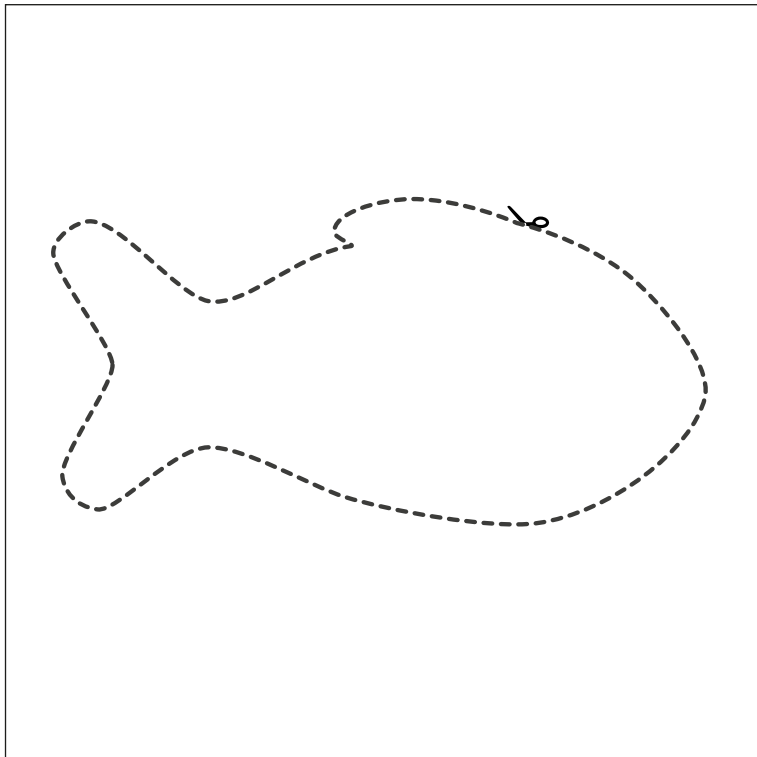
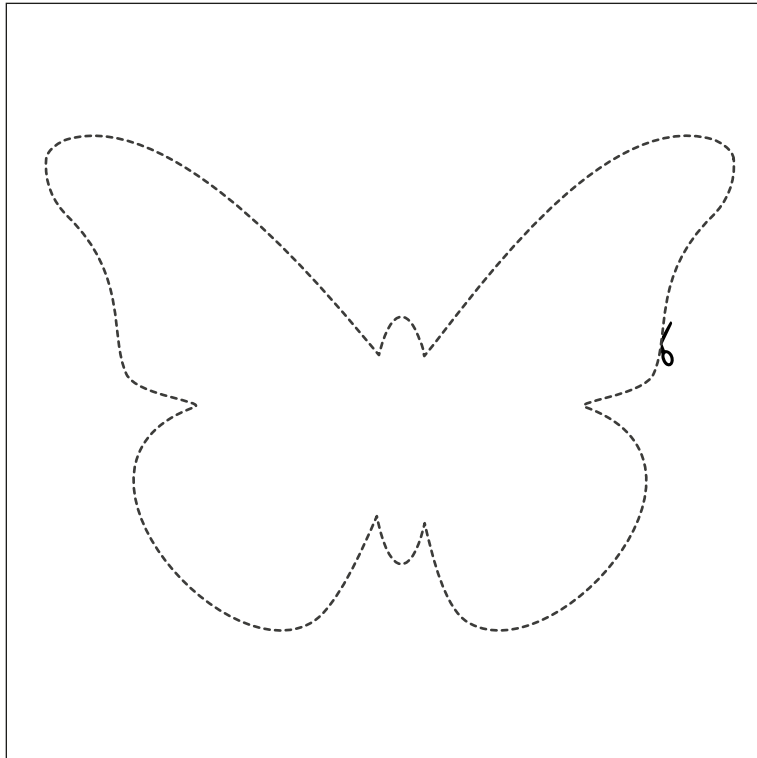



PANINI TOAST -issimi!

**DISEGNA IL TUO TOAST CON
QUESTI SIMPATICI STENCIL**

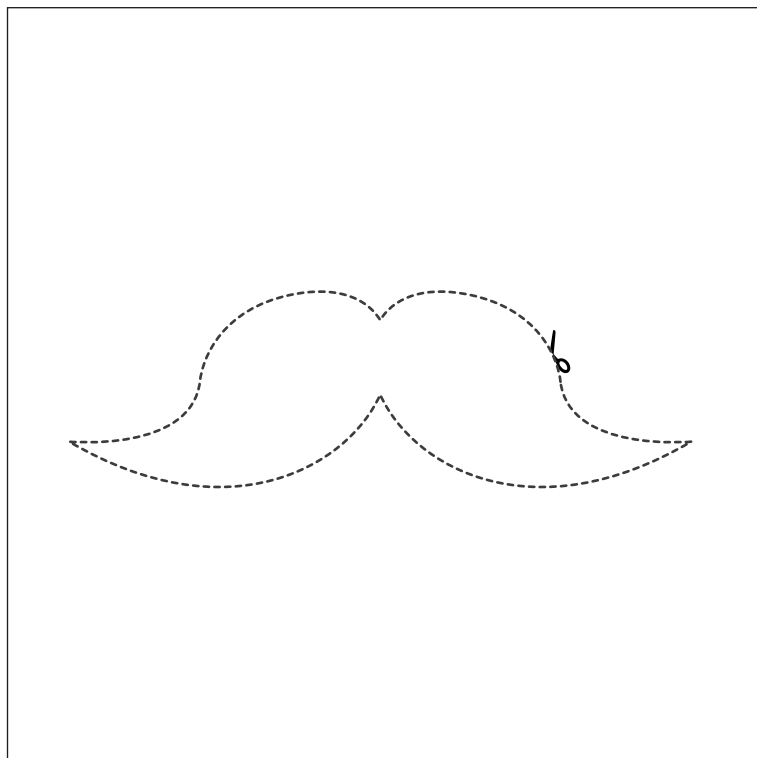
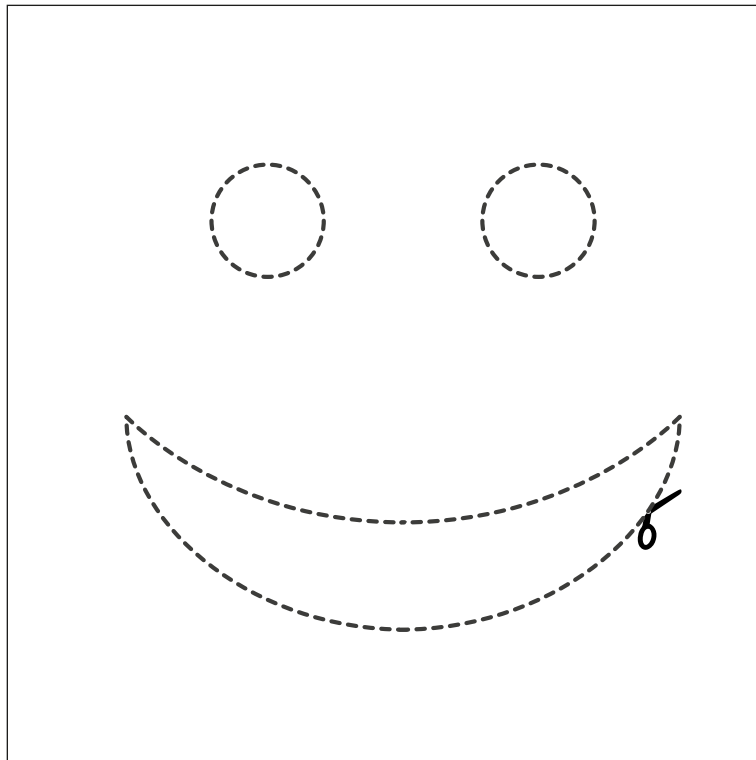



**PANINI
TOAST**
issimi!

**DISEGNA IL TUO TOAST CON
QUESTI SIMPATICI STENCIL**

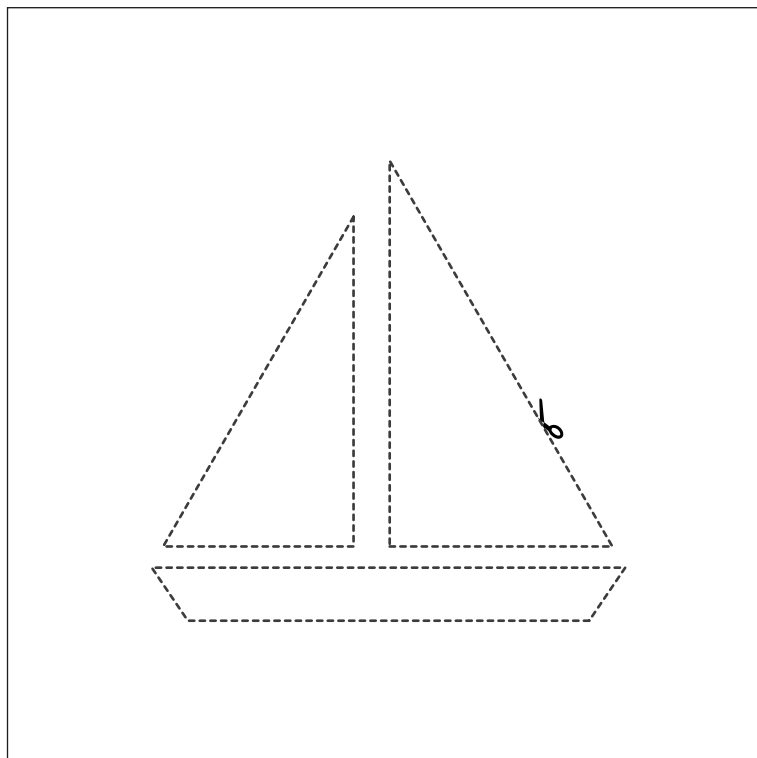
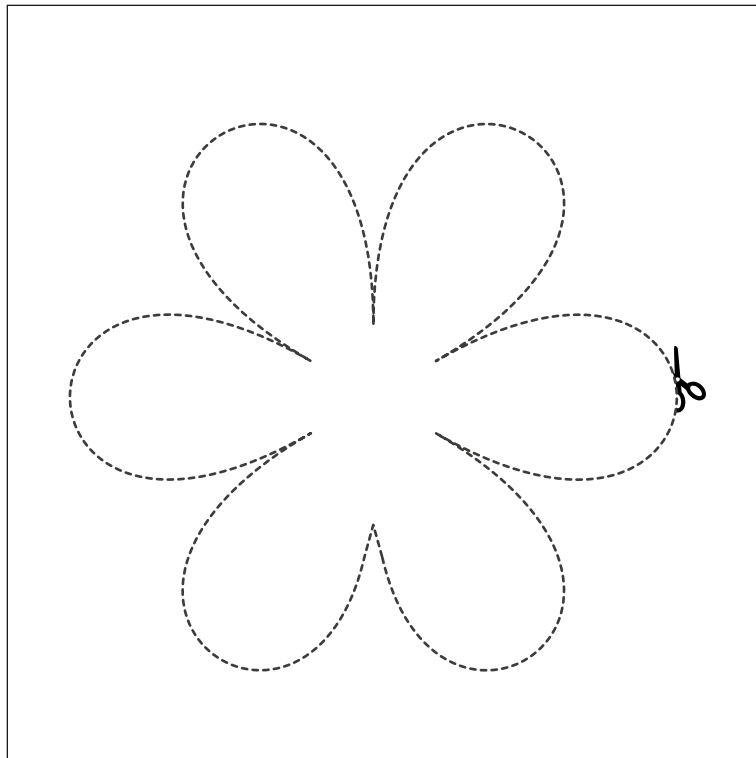



**PANINI
TOAST**
-issimi!

**DISEGNA IL TUO TOAST CON
QUESTI SIMPATICI STENCIL**

